

Rytons A1® Fire-rated S-Shape Ducting Kit 220mm x 90mm with Return Grille Double Air Brick Flanged
Custom RAL colour air brick in matt, semi-gloss or gloss finish achieving Class A2-s1, d0
RAL8004 (Copper brown) matt finish pictured
Registered Design 6087687
Patent Approved
Product Code: A1SSDK220X90RGDF

RYTONS

www.vents.co.uk

A Family Business
Since 1972

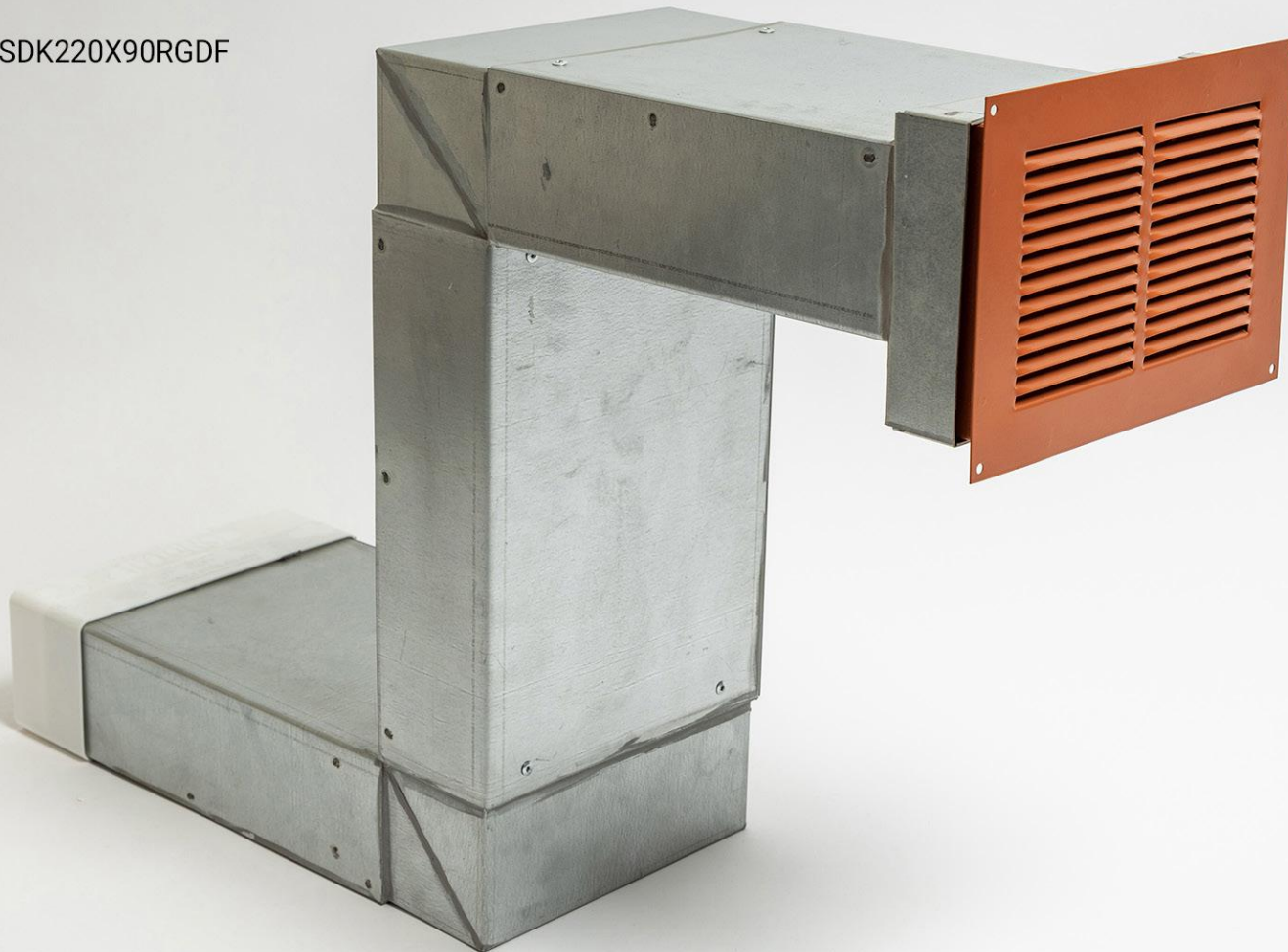

**MADE IN
BRITAIN**



EUROPEAN CLASSIFICATION A1
— NON-COMBUSTIBLE . FIRE SAFE —



DO NOT SCALE

Rytons A1® Fire-rated S-Shape Ducting Kit 220mm x 90mm with Return Grille Double Air Brick Flanged

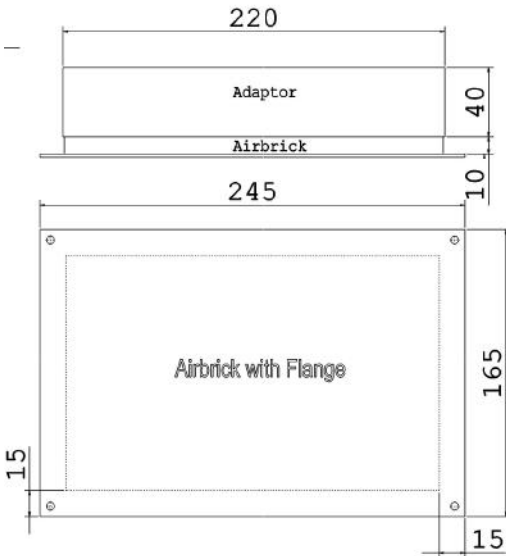
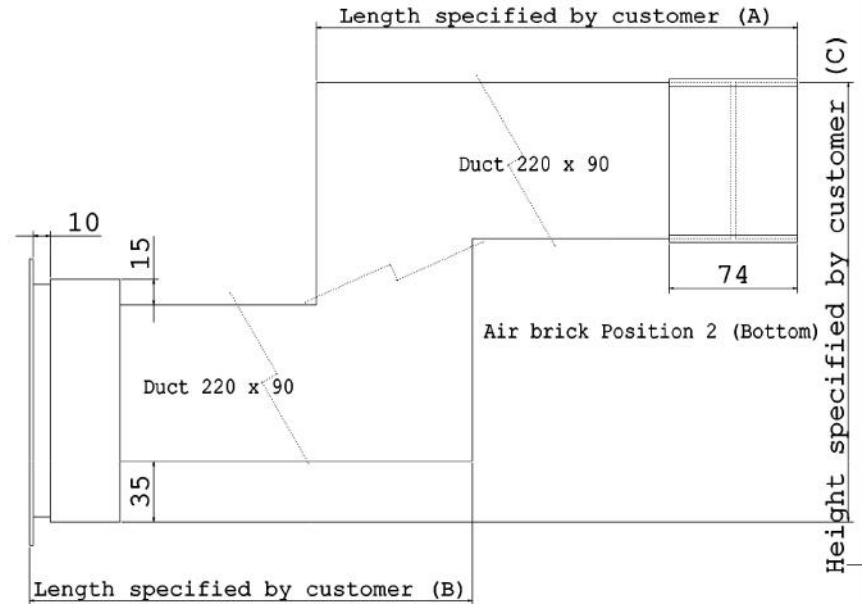
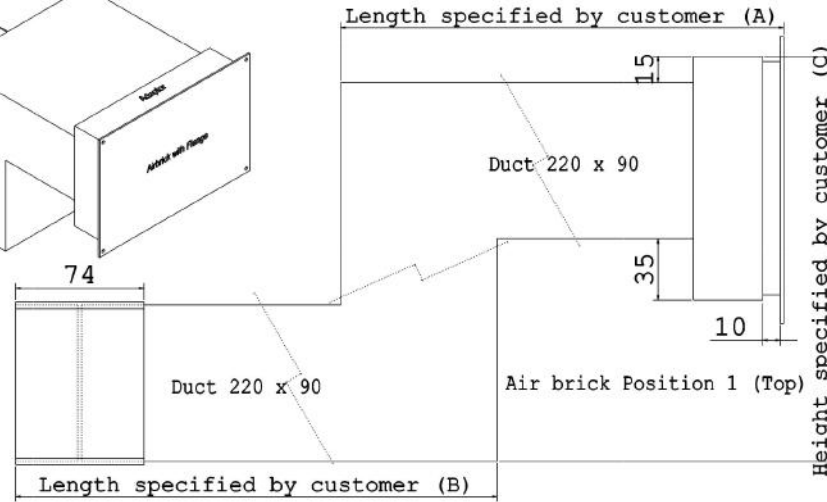
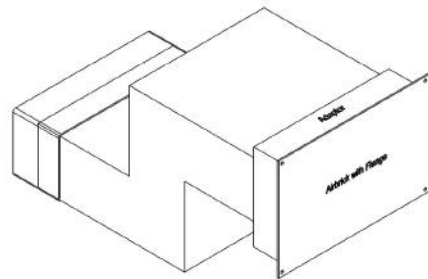

Telescopic
Up to an extra 30mm

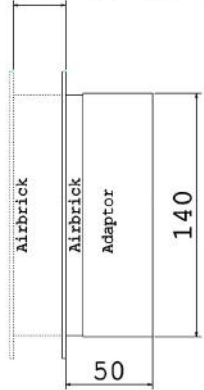

Free Area Calculation
90mm x 8mm Return Grille = 720mm ²
x26 Grilles = 18,720mm ²

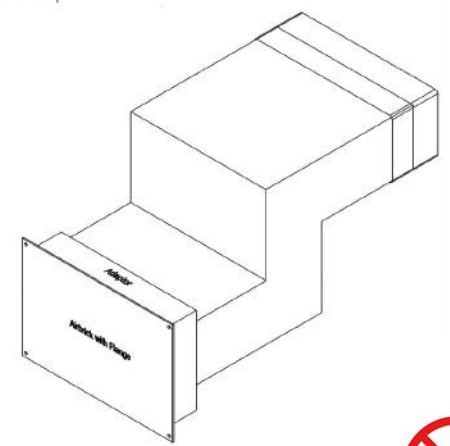

Rytons A1® Fire-rated S-Shape Ducting Kit 220mm x 90mm with Return Grille Double Air Brick Flanged

- Drawings are not to scale • Dimensions are in mm
- Products are hand made and have a tolerance of +/- 5%

Product Code:
A1SSDK220X90RGDF

Return Grille Double Air Brick Flanged
18,720mm² free area (>90% of the duct)

Registered Design 6087687
Patent Approved

V6i



Intellectual property of Rytons Building Products Ltd. Not to be copied, distributed or reproduced without Rytons written agreement. In case of query email admin@rytons.com.

