

Ryttons A1® Fire-rated S-Shape Ducting Kit 220mm x 90mm with FlowRyt® Double Air Brick Flanged
Custom RAL colour air brick in matt, semi-gloss or gloss finish achieving Class A2-s1, d0
RAL8004 (Copper brown) matt finish pictured
Registered Design 6087687
Patent Approved
Product Code: A1SSDK220X90FRDF

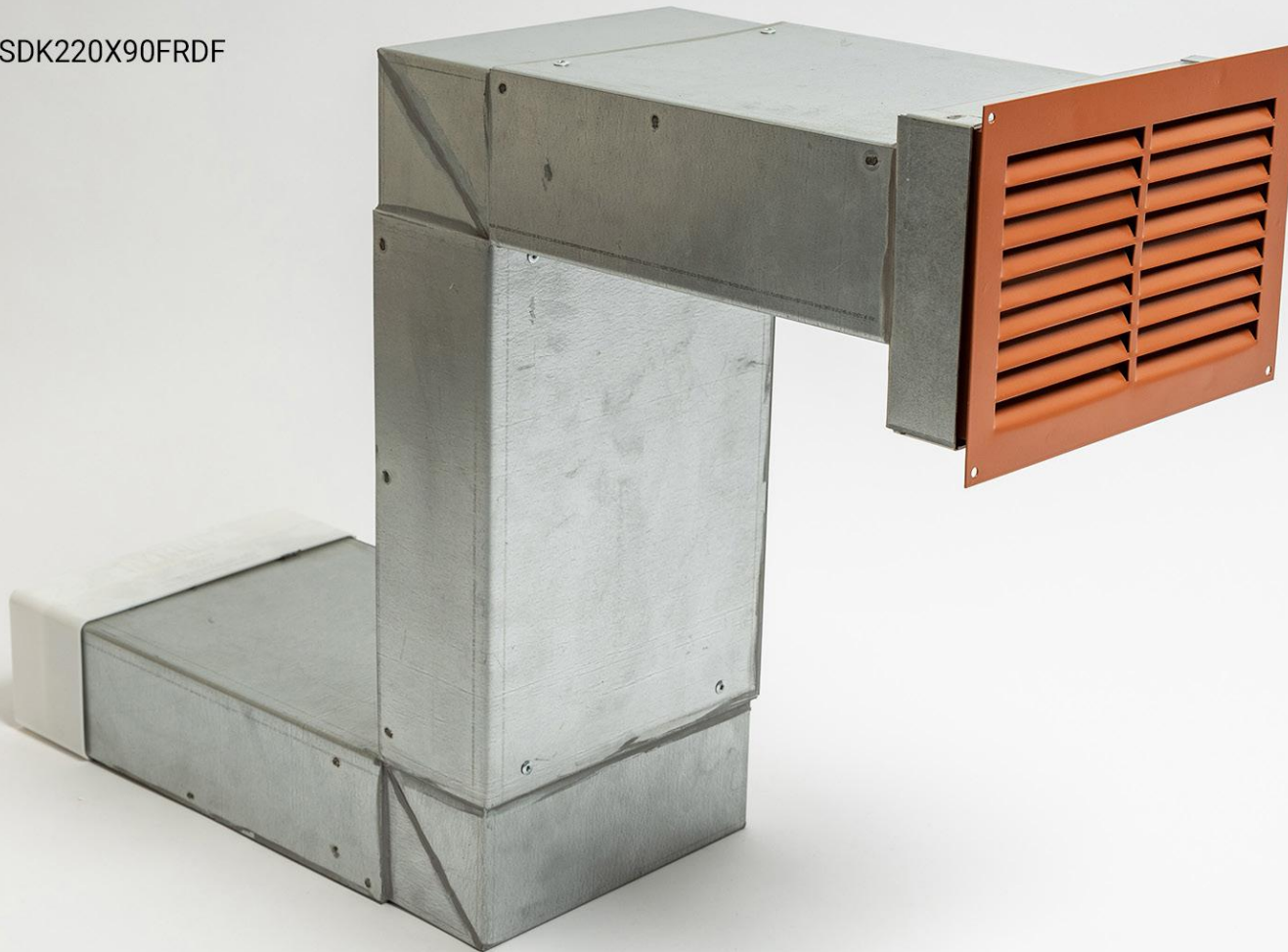

**MADE IN
BRITAIN**



EUROPEAN CLASSIFICATION A1
— NON-COMBUSTIBLE . FIRE SAFE —



DO NOT SCALE

Rytons A1® Fire-rated S-Shape Ducting Kit 220mm x 90mm with FlowRyt® Double Air Brick Flanged

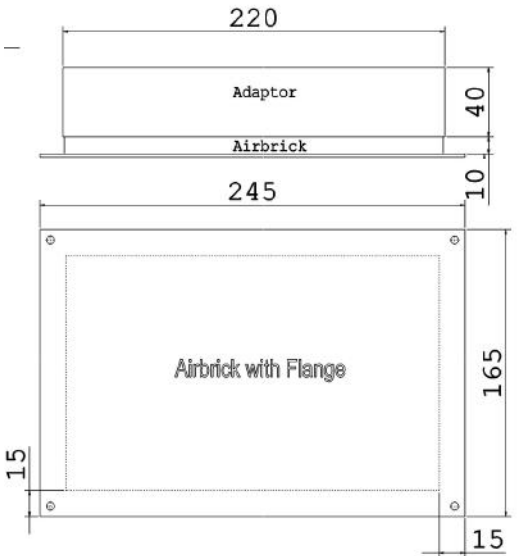
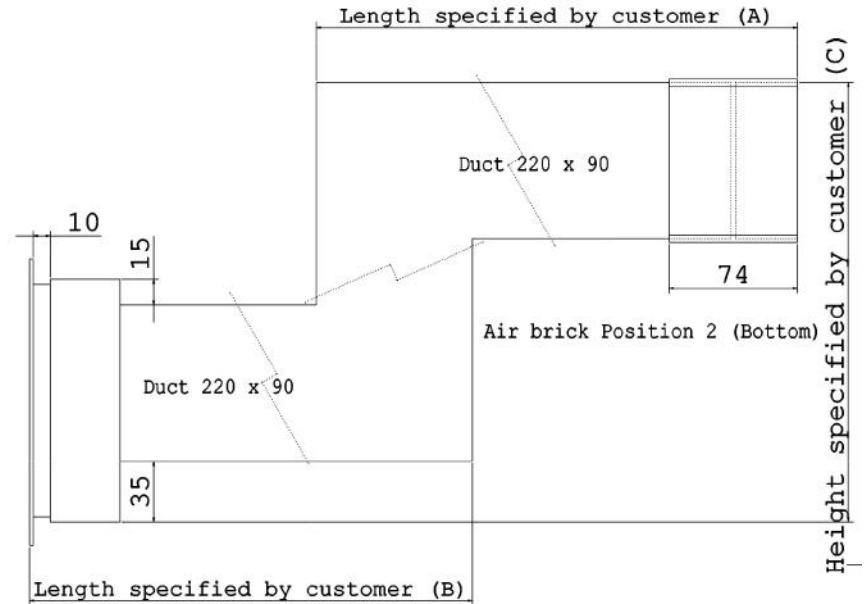
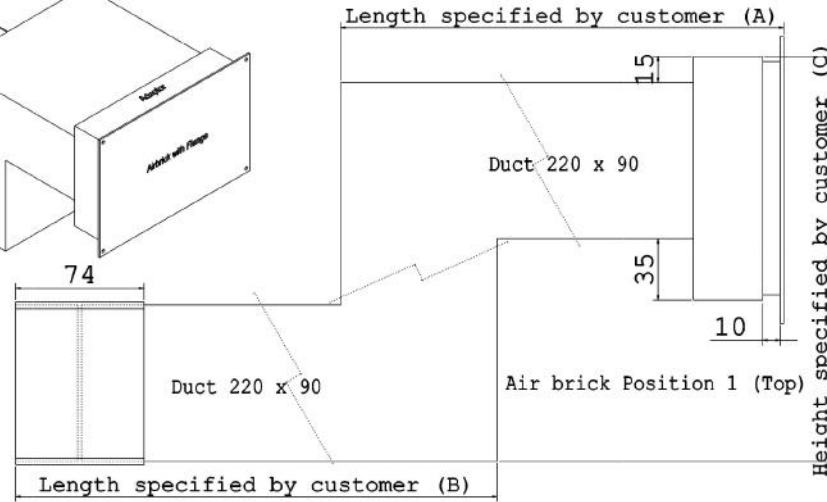
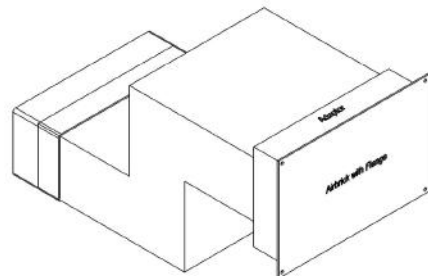

Telescopic
Up to an extra 30mm

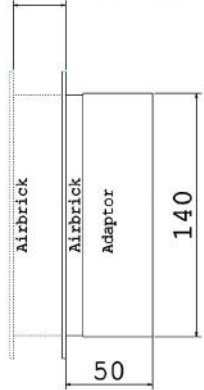

Free Area Calculation
 100mm x 10mm FlowRyt® Grille = 1,000mm²
 x18 Grilles = 18,000mm²

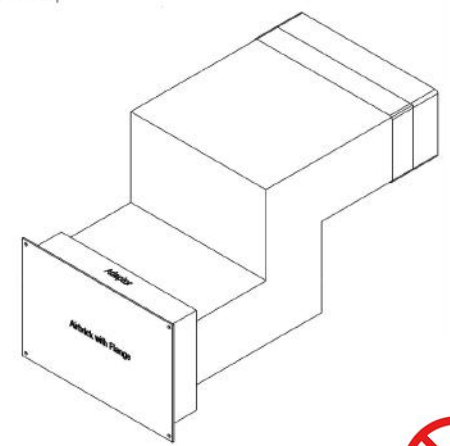

Rytons A1® Fire-rated S-Shape Ducting Kit 220mm x 90mm with FlowRyt® Double Air Brick Flanged

- Drawings are not to scale • Dimensions are in mm
- Products are hand made and have a tolerance of +/- 5%

Product Code:
A1SSDK220X90FRDF

FlowRyt® Double Air Brick Flanged
18,000mm² free area (>90% of the duct)

Registered Design 6087687
Patent Approved

V6i



Intellectual property of Rytons Building Products Ltd. Not to be copied, distributed or reproduced without Rytons written agreement. In case of query email admin@rytons.com.