

Rytons A1® Fire-rated 90° Ducting Kit 220mm x 90mm with FlowRyt® Double Air Brick Flanged  
Custom RAL colour air brick in matt, semi-gloss or gloss finish achieving Class A2-s1, d0  
RAL8004 (Copper brown) matt finish pictured  
Registered Design 6085482  
Patent Approved  
Product Code: A190DK220X90FRDF

**RYTONS**  
www.vents.co.uk  
*A Family Business*  
*Since 1972*

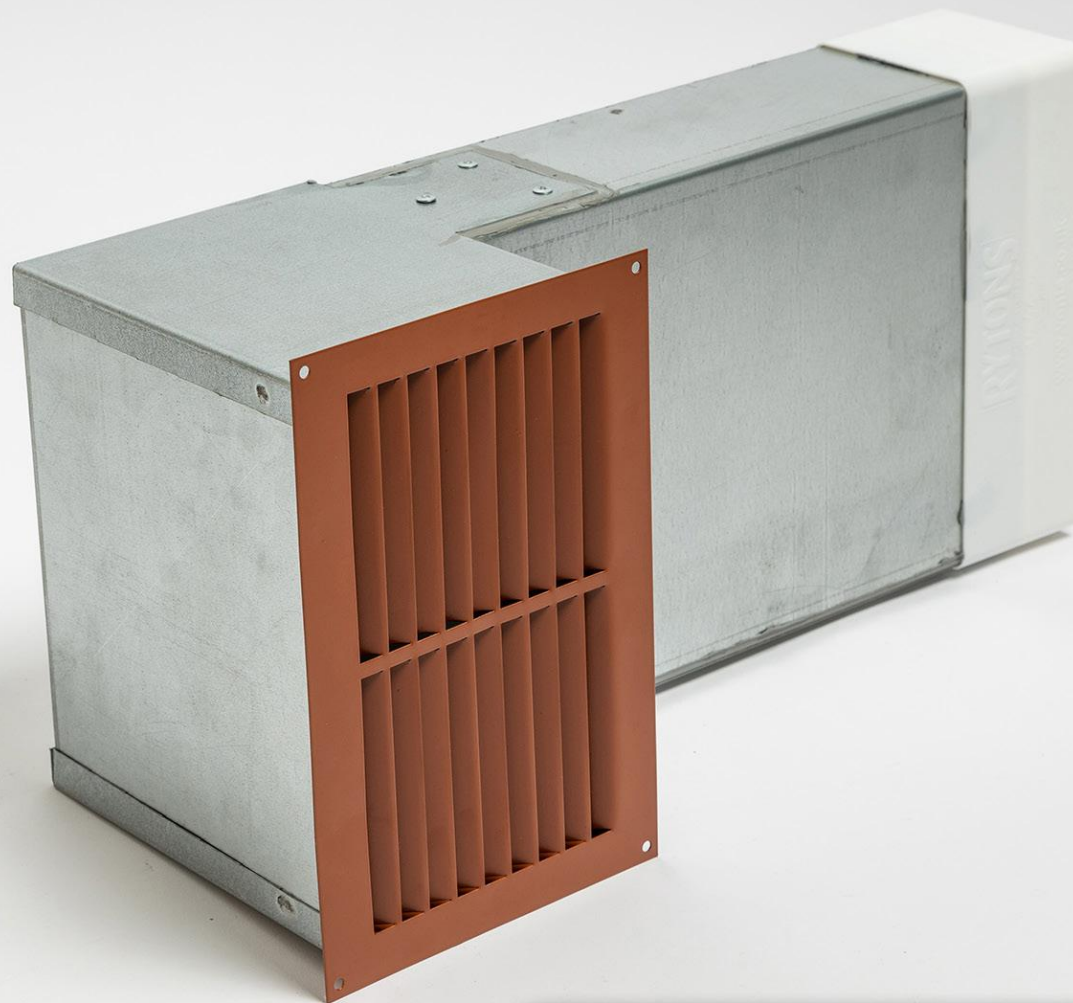

**MADE IN BRITAIN**



**EUROPEAN CLASSIFICATION A1**  
— NON-COMBUSTIBLE . FIRE SAFE —



DO NOT SCALE

# Rytons A1® Fire-rated 90° Ducting Kit 220mm x 90mm with FlowRyt® Double Air Brick Flanged

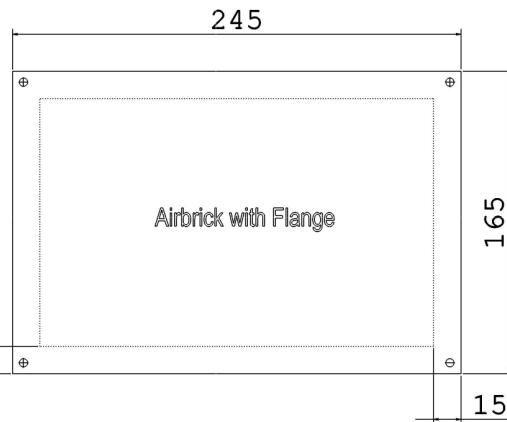
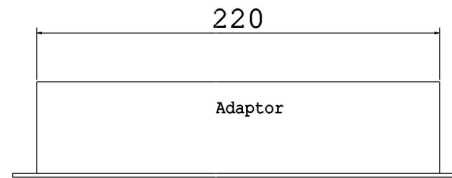
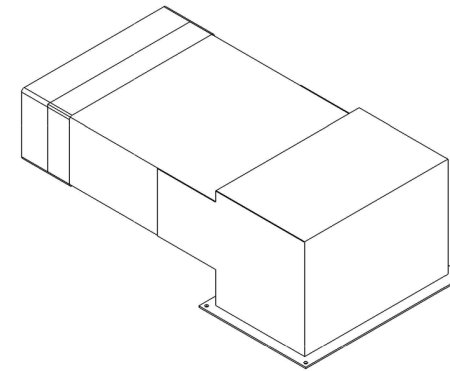
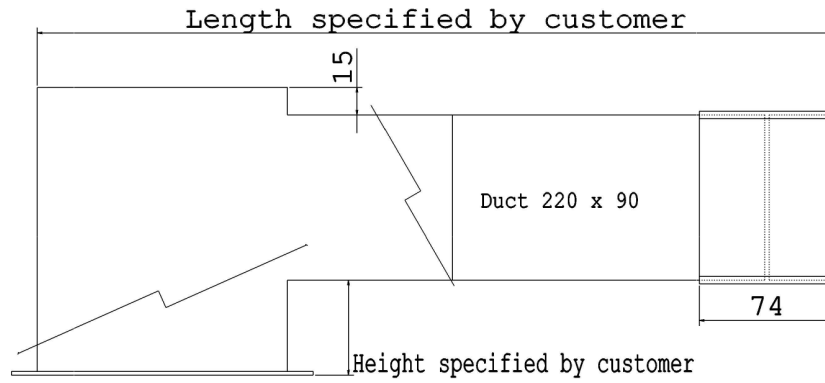

Telescopic  
Up to an extra 40mm

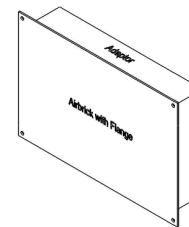
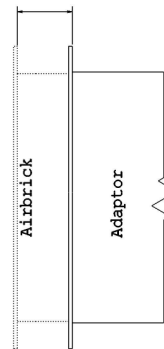

Free Area Calculation
100mm x 10mm FlowRyt® Grille = 1,000mm <sup>2</sup>
x18 Grilles = 18,000mm <sup>2</sup>



Rytons A1® Fire-rated 90° Ducting Kit 220mm x 90mm with FlowRyt® Double Air Brick Flanged

Product Code:  
A190DK220X90FRDF

FlowRyt® Double Air Brick Flanged  
18,000mm<sup>2</sup> free area (> 90% of the duct)

Registered Design 6085482  
Patent Approved

V5i



- Drawings are not to scale
- Dimensions are in mm
- Products are hand made and have a tolerance of +/- 5%

Intellectual property of Rytons Building Products Ltd. Not to be copied, distributed or reproduced without Rytons written agreement. In case of query email [admin@rytons.com](mailto:admin@rytons.com).

