

Rytons A1® Fire-rated 90° Ducting Kit 220mm x 90mm with FlowRyt® Double Air Brick Flanged  
Custom RAL colour air brick in matt, semi-gloss or gloss finish achieving Class A2-s1, d0  
RAL8004 (Copper brown) matt finish pictured  
Registered Design 6085482  
Patent Pending  
Product Code: A190DK220X90FRDF

**RYTONS**  
www.vents.co.uk  
*A Family Business*  
*Since 1972*

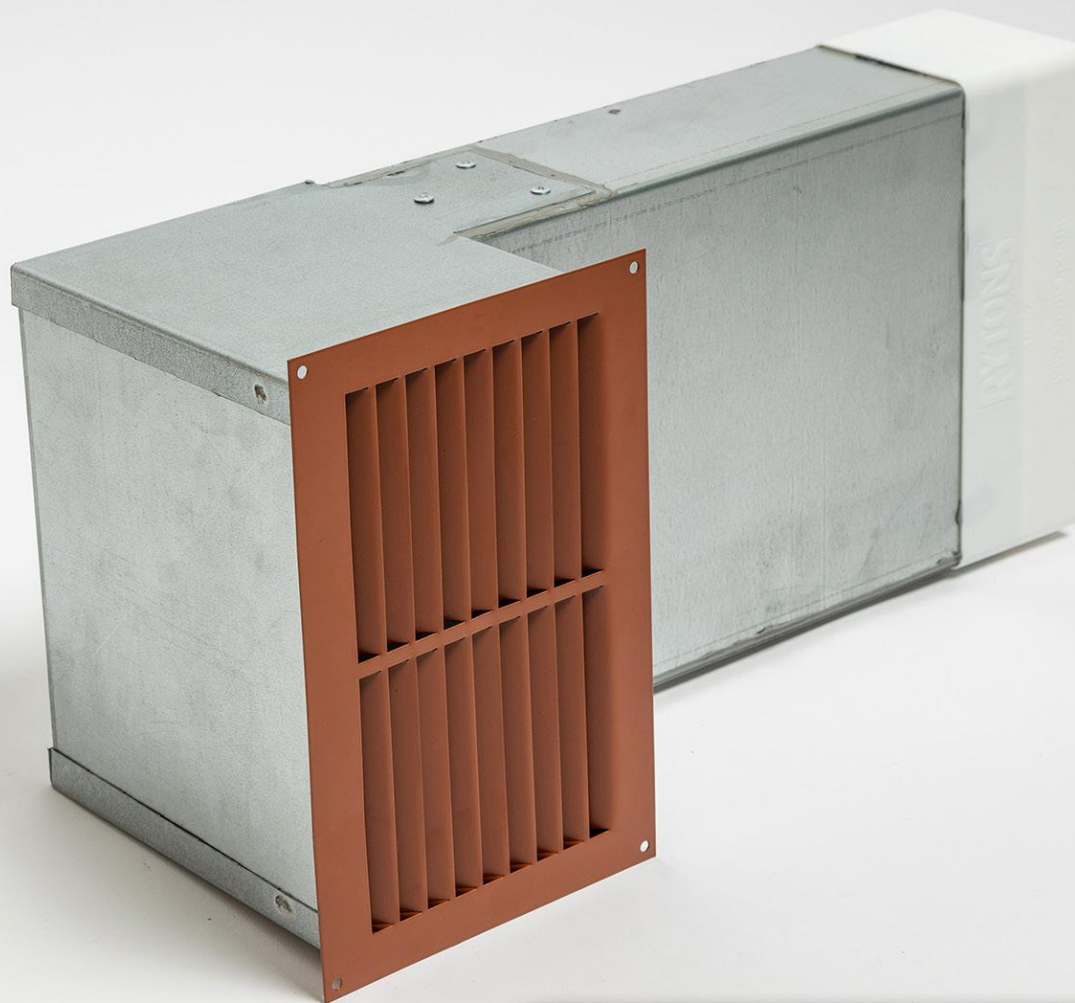

**MADE IN  
BRITAIN**



**EUROPEAN CLASSIFICATION A1**  
— NON-COMBUSTIBLE . FIRE SAFE —



DO NOT SCALE

Rytons A1® Fire-rated 90° Ducting Kit 220mm x 90mm with FlowRyt® Double Air Brick Flanged

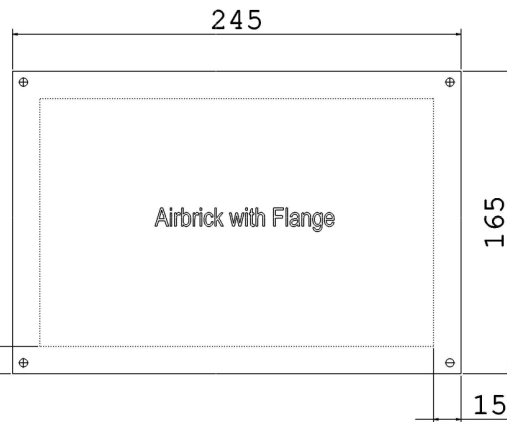
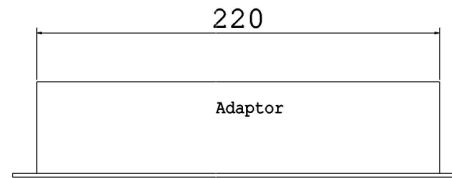
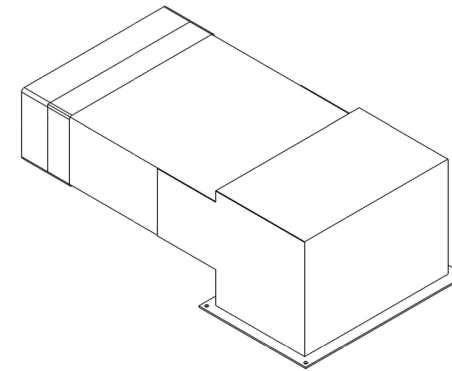
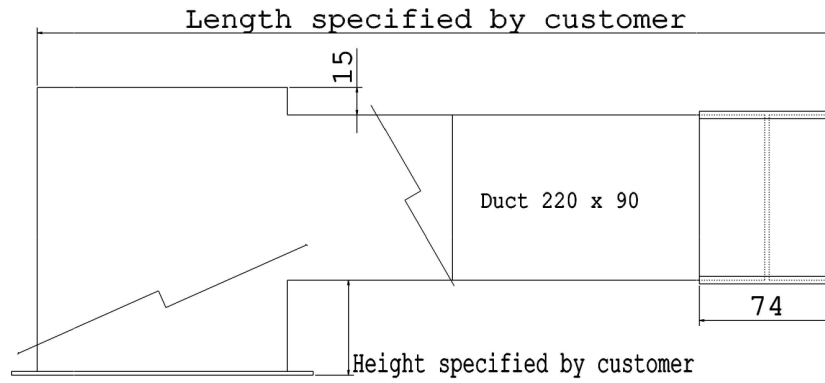

Telescopic  
Up to an extra 40mm

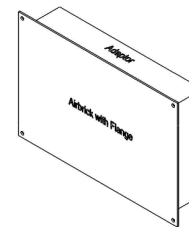
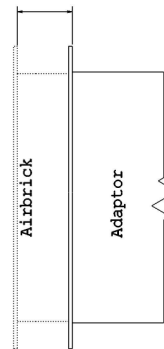

Free Area Calculation
100mm x 10mm FlowRyt® Grille = 1,000mm <sup>2</sup>
x18 Grilles = 18,000mm <sup>2</sup>



Rytons A1® Fire-rated 90° Ducting Kit 220mm x 90mm with FlowRyt® Double Air Brick Flanged

- Drawings are not to scale
- Dimensions are in mm
- Products are hand made and have a tolerance of +/- 5%

Product Code:  
A190DK220X90FRDF

FlowRyt® Double Air Brick Flanged  
18,000mm<sup>2</sup> free area (> 90% of the duct)

Registered Design 6085482  
Patent Pending

V5



Intellectual property of Rytons Building Products Ltd. Not to be copied, distributed or reproduced without Rytons written agreement. In case of query email admin@rytons.com.

