

Ryttons A1® Fire-rated Retrofit Ducting Kit 204mm x 60mm with Square Holed Single Air Brick Flanged  
Custom RAL colour air brick in matt, semi-gloss or gloss finish achieving Class A2-s1, d0  
RAL1019 (Grey beige) matt finish pictured  
Registered Design 6085466  
Patent Approved  
Product Code: A1RFDK204X60SQSF

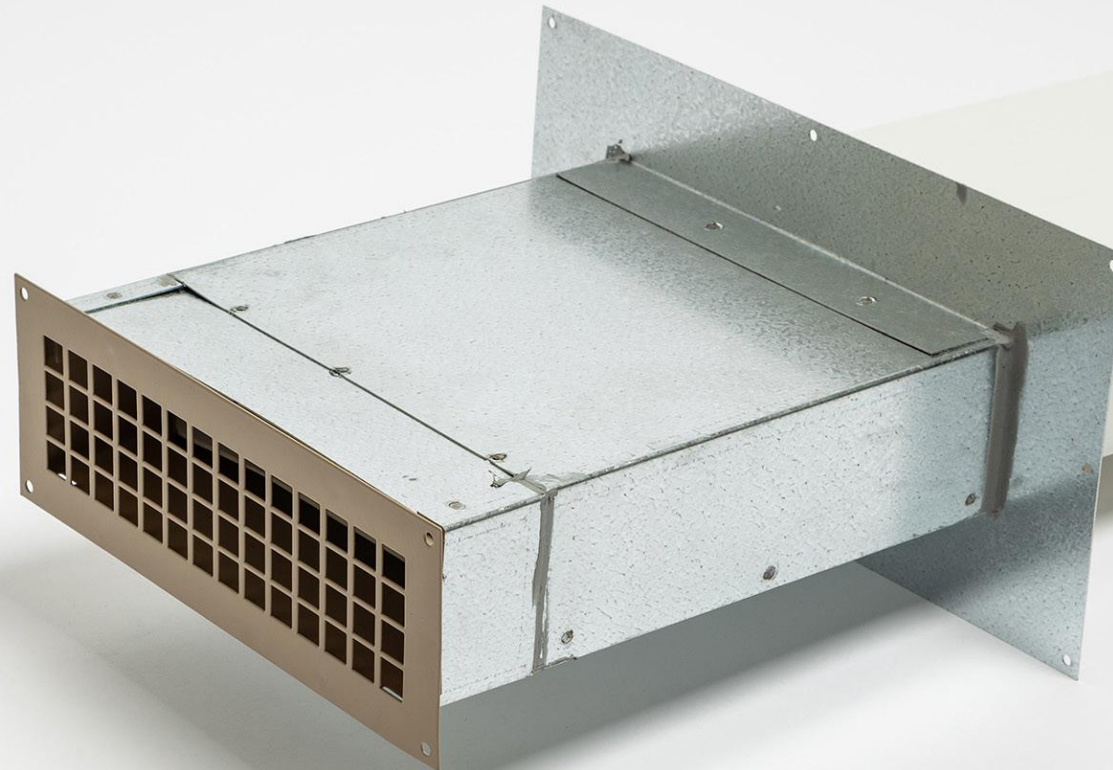

**MADE IN  
BRITAIN**



**EUROPEAN CLASSIFICATION A1**  
— NON-COMBUSTIBLE . FIRE SAFE —



DO NOT SCALE

# Rytons A1® Fire-rated Retrofit Ducting Kit 204mm x 60mm with Square Holed Single Air Brick Flanged

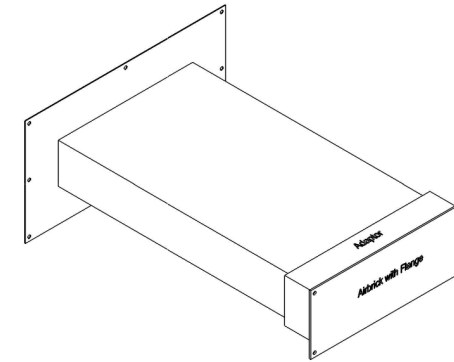
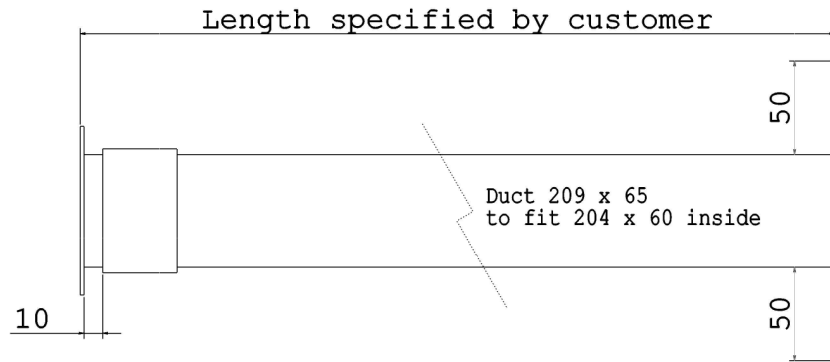

**Free Area Calculation**  
 12.7mm x 12.7mm Square Hole = 161.29mm<sup>2</sup>  
 x56 Holes = 9,032.24mm<sup>2</sup>

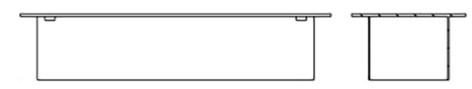
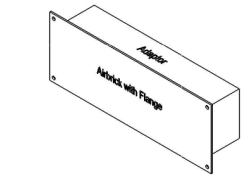
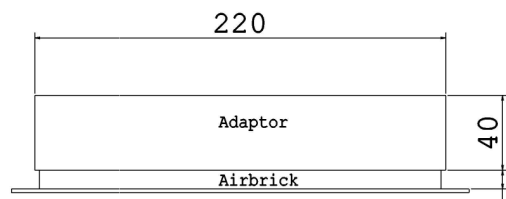

Telescopic  
 Up to an  
 extra 30mm

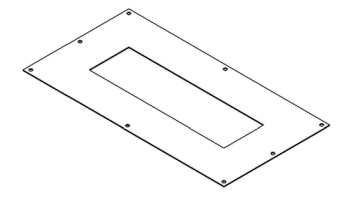
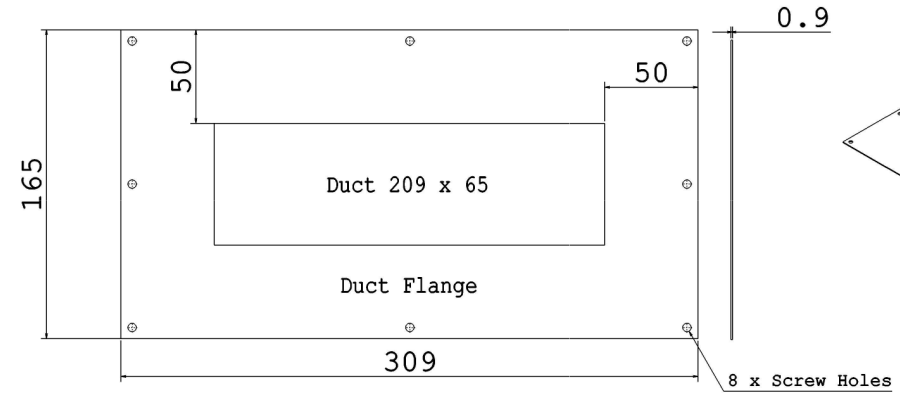
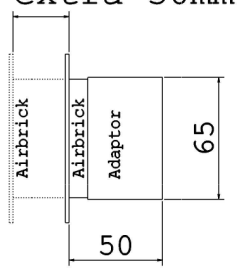
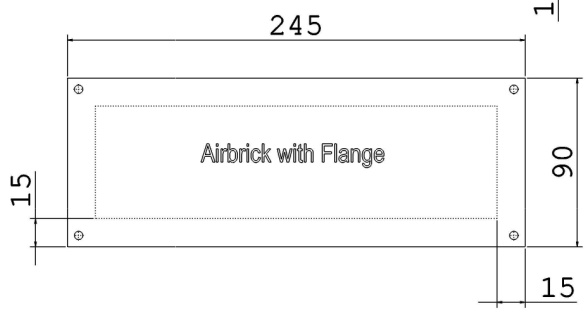

Rytons A1® Fire-rated Retrofit Ducting Kit 204mm x 60mm with Square Holed Single Air Brick Flanged

- Drawings are not to scale
- Dimensions are in mm
- Products are hand made and have a tolerance of +/- 5%

Product Code: A1RFDK204X60SQSF

Intellectual property of Rytons Building Products Ltd. Not to be copied, distributed or reproduced without Rytons written agreement. In case of query email admin@rytons.com.

Square Holed Single Air Brick Flanged  
 9,032mm<sup>2</sup> free area

Registered Design 6085466  
 Patent Approved

V4i

