

Rytons A1® Fire-rated Retrofit Ducting Kit 204mm x 60mm with Square Holed Single Air Brick Flanged
Custom RAL colour air brick in matt, semi-gloss or gloss finish achieving Class A2-s1, d0
RAL1019 (Grey beige) matt finish pictured
Registered Design 6085466
Patent Pending
Product Code: A1RFDK204X60SQSF

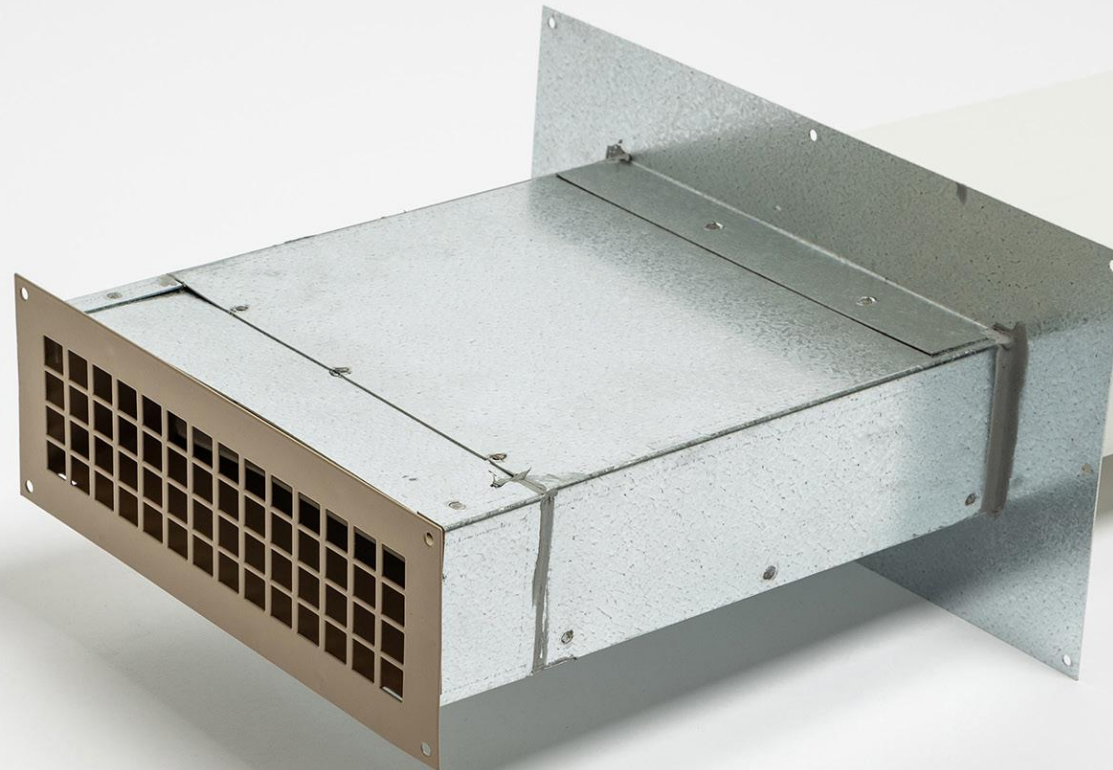

**MADE IN
BRITAIN**



EUROPEAN CLASSIFICATION A1
— NON-COMBUSTIBLE . FIRE SAFE —



DO NOT SCALE

Rytons A1® Fire-rated Retrofit Ducting Kit 204mm x 60mm with Square Holed Single Air Brick Flanged

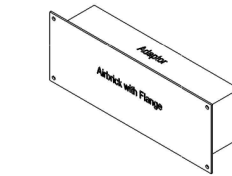
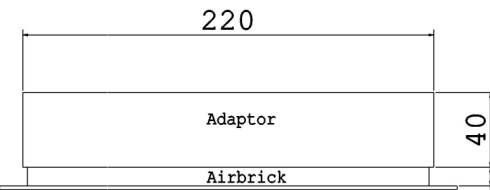
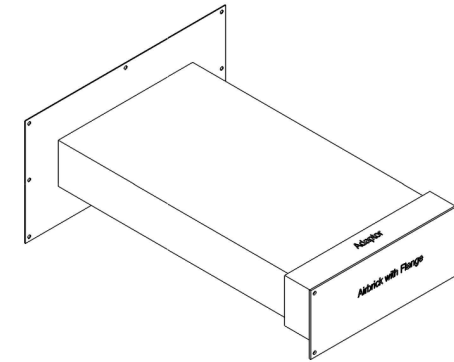
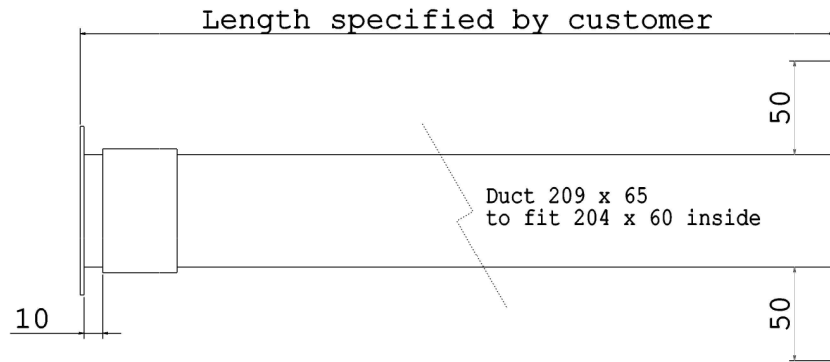

Free Area Calculation
12.7mm x 12.7mm Square Hole = 161.29mm ²
x56 Holes = 9,032.24mm ²

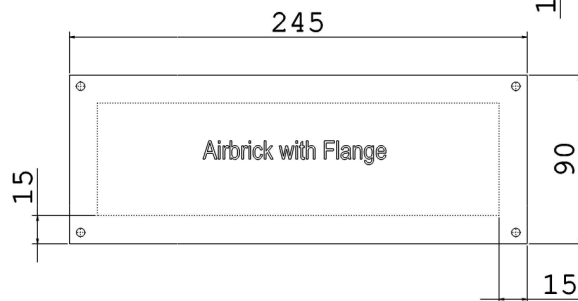

Telescopic
Up to an
extra 30mm

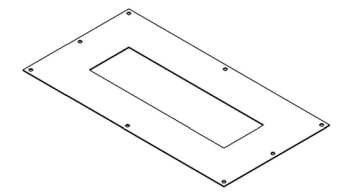
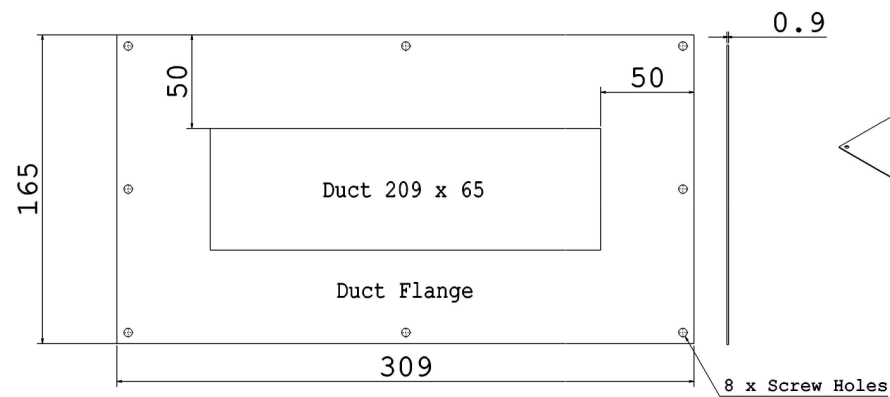
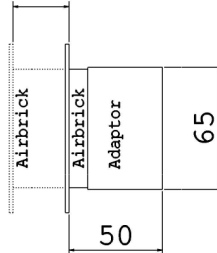

Rytons A1® Fire-rated Retrofit Ducting Kit 204mm x 60mm with Square Holed Single Air Brick Flanged

Product Code: A1RFDK204X60SQSF

Square Holed Single Air Brick Flanged 9,032mm² free area

Registered Design 6085466 Patent Pending

V4



• Drawings are not to scale • Dimensions are in mm
• Products are hand made and have a tolerance of +/- 5%

Intellectual property of Rytons Building Products Ltd. Not to be copied, distributed or reproduced without Rytons written agreement. In case of query email admin@rytons.com.

