

Rytons A1® Fire-rated Retrofit Ducting Kit 204mm x 60mm with Return Grille Single Air Brick Flanged  
Custom RAL colour air brick in matt, semi-gloss or gloss finish achieving Class A2-s1, d0  
RAL1019 (Grey beige) matt finish pictured  
Registered Design 6085466  
Patent Pending  
Product Code: A1RFDK204X60RGSF

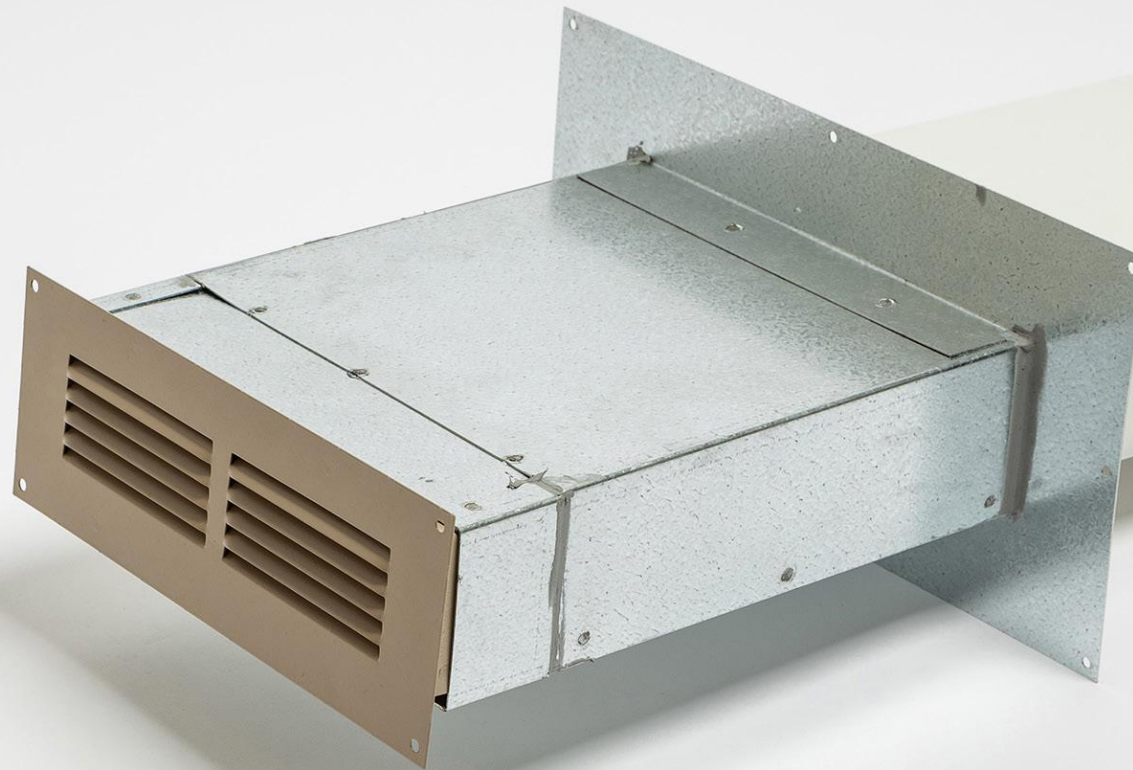

**MADE IN  
BRITAIN**



**EUROPEAN CLASSIFICATION A1**  
— NON-COMBUSTIBLE . FIRE SAFE —



DO NOT SCALE

Rytons A1® Fire-rated Retrofit Ducting Kit 204mm x 60mm with Return Grille Single Air Brick Flanged

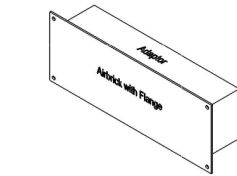
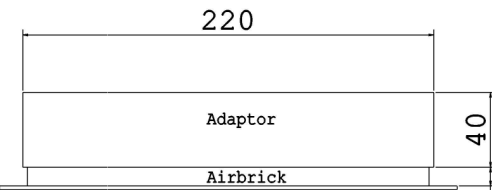
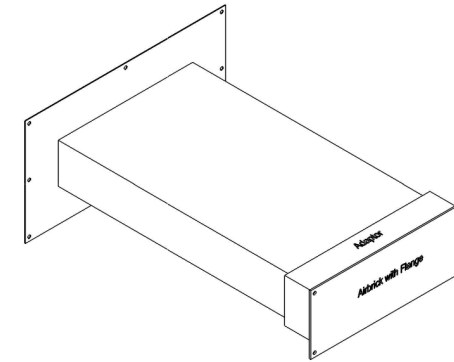
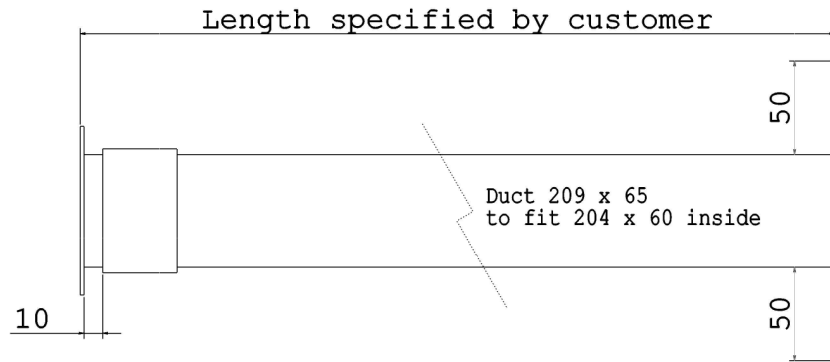

<b>Free Area Calculation</b>
90mm x 8mm Return Grille = 720mm <sup>2</sup>
x10 Grilles = 7,200mm <sup>2</sup>

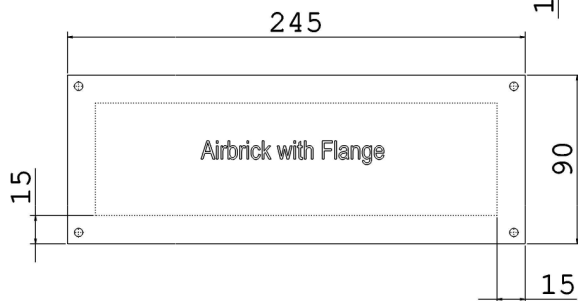

Telescopic  
Up to an  
extra 30mm

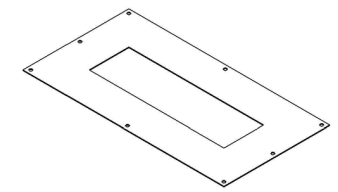
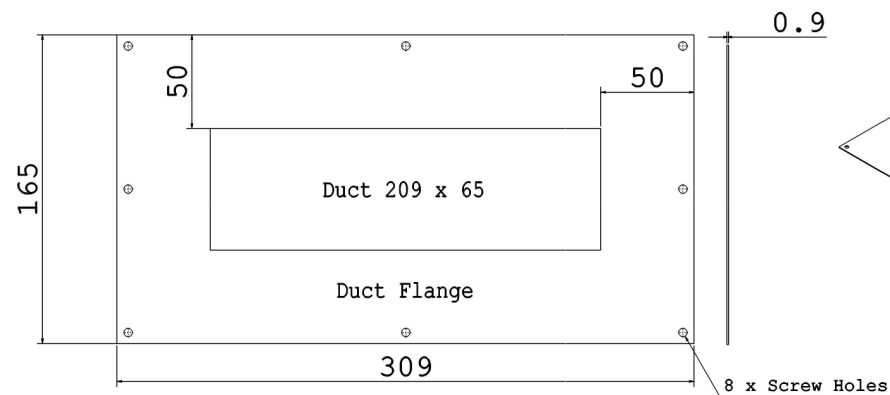
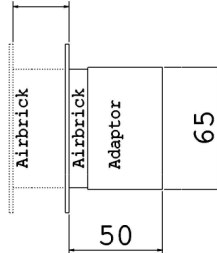

Rytons A1® Fire-rated Retrofit Ducting Kit 204mm x 60mm with Return Grille Single Air Brick Flanged

Product Code: A1RFDK204X60RGSF

Return Grille Single Air Brick Flanged 7,200mm<sup>2</sup> free area

Registered Design 6085466 Patent Pending

V4



• Drawings are not to scale • Dimensions are in mm  
• Products are hand made and have a tolerance of +/- 5%

Intellectual property of Rytons Building Products Ltd. Not to be copied, distributed or reproduced without Rytons written agreement. In case of query email admin@rytons.com.

