

Rytons A1® Fire-rated Retrofit Ducting Kit 204mm x 60mm with FlowRyt® Single Air Brick Flanged
Custom RAL colour air brick in matt, semi-gloss or gloss finish achieving Class A2-s1, d0
RAL1019 (Grey beige) matt finish pictured
Registered Design 6085466
Patent Pending
Product Code: A1RFDK204X60FRSF

RYTONS
www.vents.co.uk
A Family Business
Since 1972

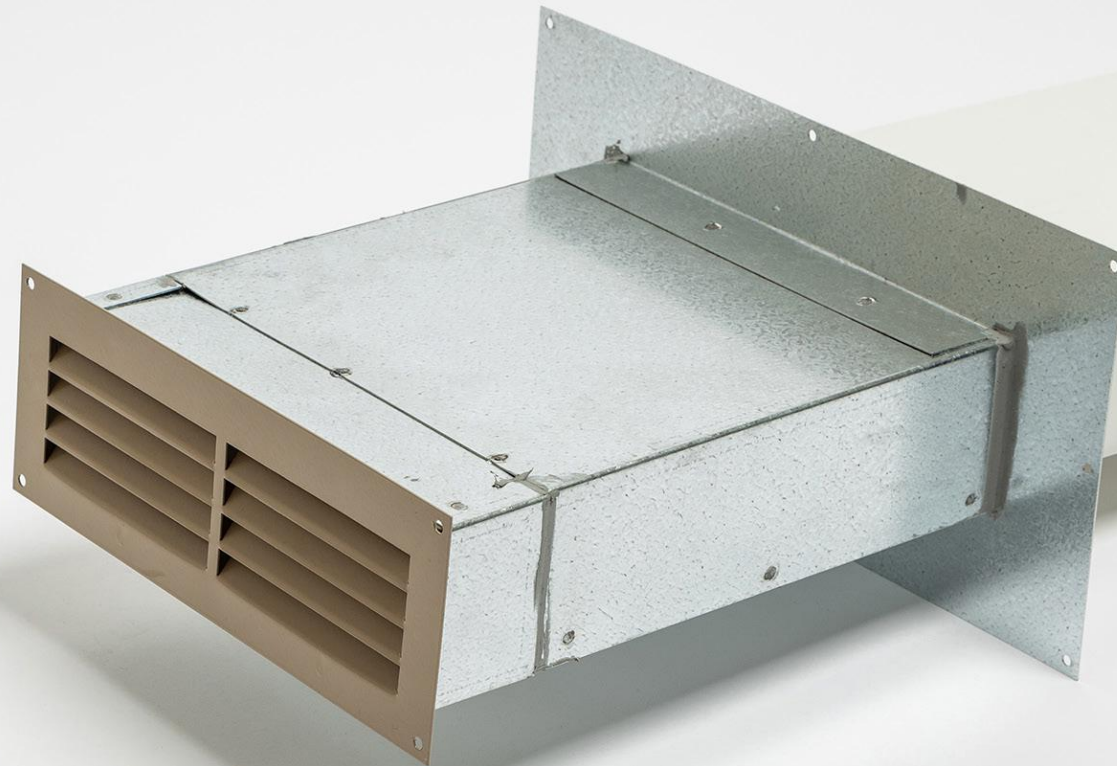

**MADE IN
BRITAIN**



EUROPEAN CLASSIFICATION A1
— NON-COMBUSTIBLE . FIRE SAFE —



DO NOT SCALE

Rytons A1® Fire-rated Retrofit Ducting Kit 204mm x 60mm with FlowRyt® Single Air Brick Flanged

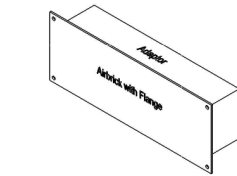
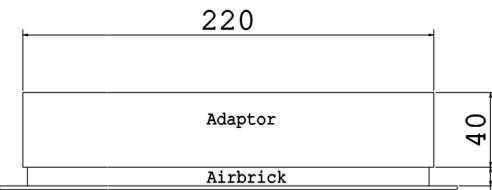
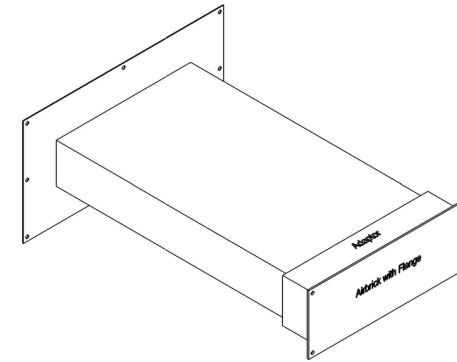
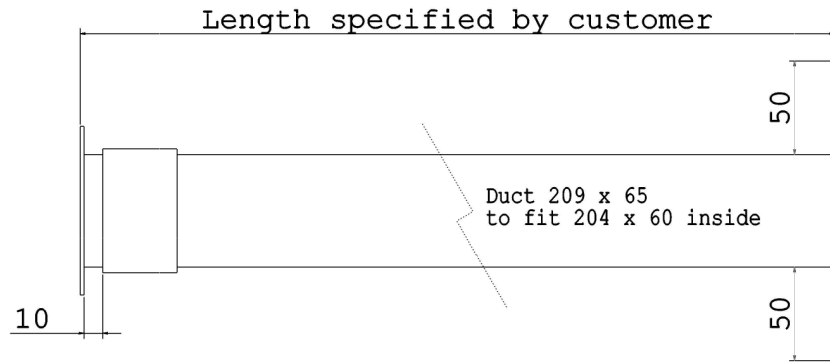

Free Area Calculation
100mm x 10mm FlowRyt® Grille = 1,000mm ²
x8 Grilles = 8,000mm ²

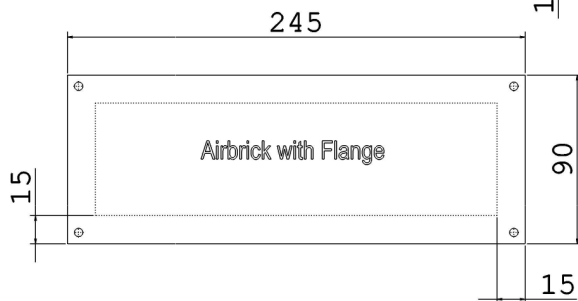

Telescopic
Up to an
extra 30mm

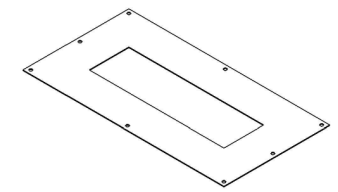
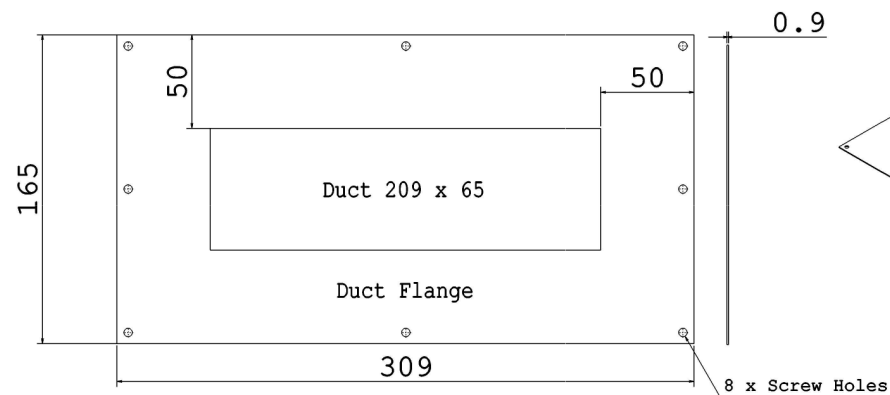
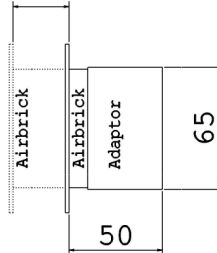

Rytons A1® Fire-rated Retrofit Ducting Kit 204mm x 60mm with FlowRyt® Single Air Brick Flanged

Product Code:
A1RFDK204X60FRSF

FlowRyt® Single Air Brick Flanged
8,000mm² free area

Registered Design 6085466
Patent Pending

V4



• Drawings are not to scale • Dimensions are in mm
• Products are hand made and have a tolerance of +/- 5%

Intellectual property of Rytons Building Products Ltd. Not to be copied, distributed or reproduced without Rytons written agreement. In case of query email admin@rytons.com.

