

Rytons A1® Fire-rated 9x3 AirLiner®

Custom RAL colour air brick in matt, semi-gloss or gloss finish achieving Class A2-s1, d0

Registered Design

Patent Pending

**RYTONS**

[www.vents.co.uk](http://www.vents.co.uk)

*A Family Business*

*Since 1972*

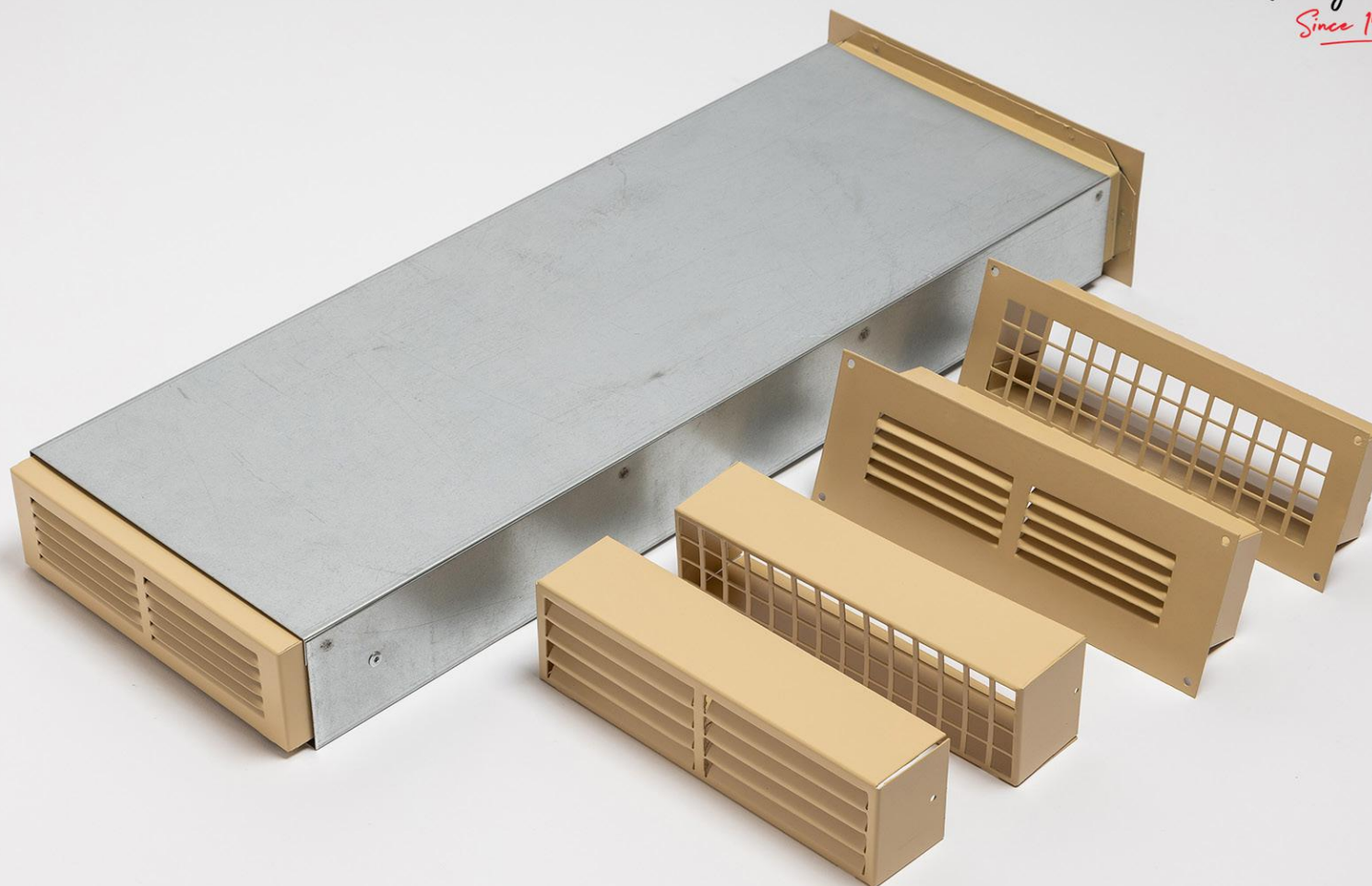

**MADE IN BRITAIN**



**EUROPEAN CLASSIFICATION A1**  
— NON-COMBUSTIBLE . FIRE SAFE —



DO NOT SCALE

# Rytons A1® Fire-rated 9x3 AirLiner®

(Available with or without Rytons A1® Fire-rated Metal Single Air Bricks)

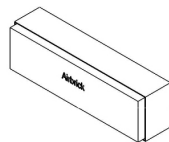
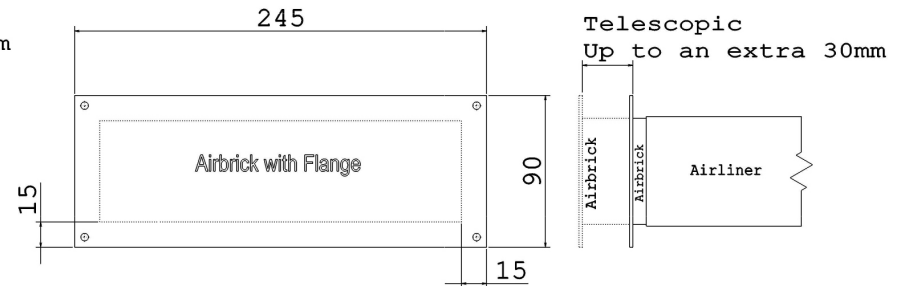
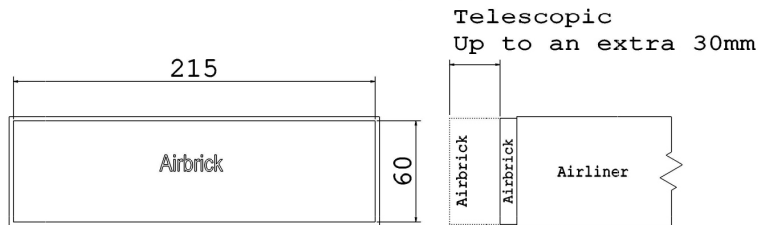
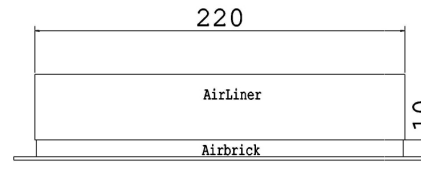
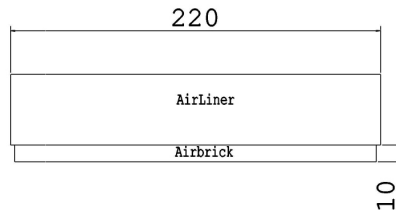
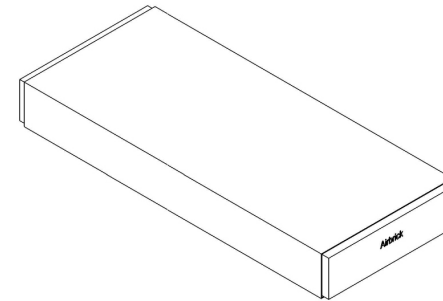
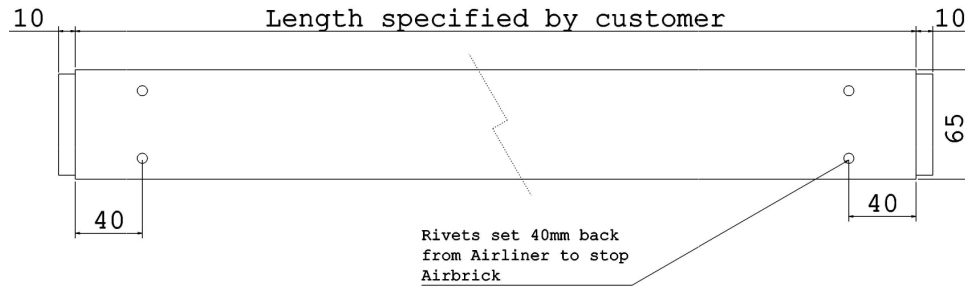

Rytons A1® Fire-rated 9x3 AirLiner®

Product Code:  
A1AL93

Free area is dependent on which of Rytons A1®  
Fire-rated Metal Single Air Bricks is used

Registered Design 6087696  
& 6087697 | Patent Pending

V3



• Drawings are not to scale • Dimensions are in mm  
• Products are hand made and have a tolerance of +/- 5%

Intellectual property of Rytons Building Products Ltd. Not to be copied, distributed or reproduced without  
Rytons written agreement. In case of query email [admin@rytons.com](mailto:admin@rytons.com).

